





## HANDGREEP TUBOCOLOR met douche & zeep houder

















**BioCote® technology**

Handgrepen om in hoeken te plaatsen, met douche & zeephouder van naadloze verzinkte stalen buis, gecoat met antibacterieel, ( BioCote ) in soft-touch vinyl

Deze handgreep is ideaal voor het gebruik in douches en sanitaire ruimtes, voor een maximale veiligheid voor de gebruiker, beschikbaar in links of rechtshandig.

- Toepassing: privé woningen, serviceflats, woonzorgcentra en hotels, enz....
- Draagcapaciteit: Verticaal 150kg, horizontaal 40kg
- Afmeting: A1xC1: 620x1120 mm

- Kleuren: 

														
B1	B2	D1	D2	D4	G1	G2	I1	I2	P4	R1	R7	W1	Y1	Y3



## HANDGREEP TUBOCOLOR met douche & zeep houder

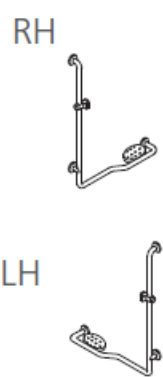
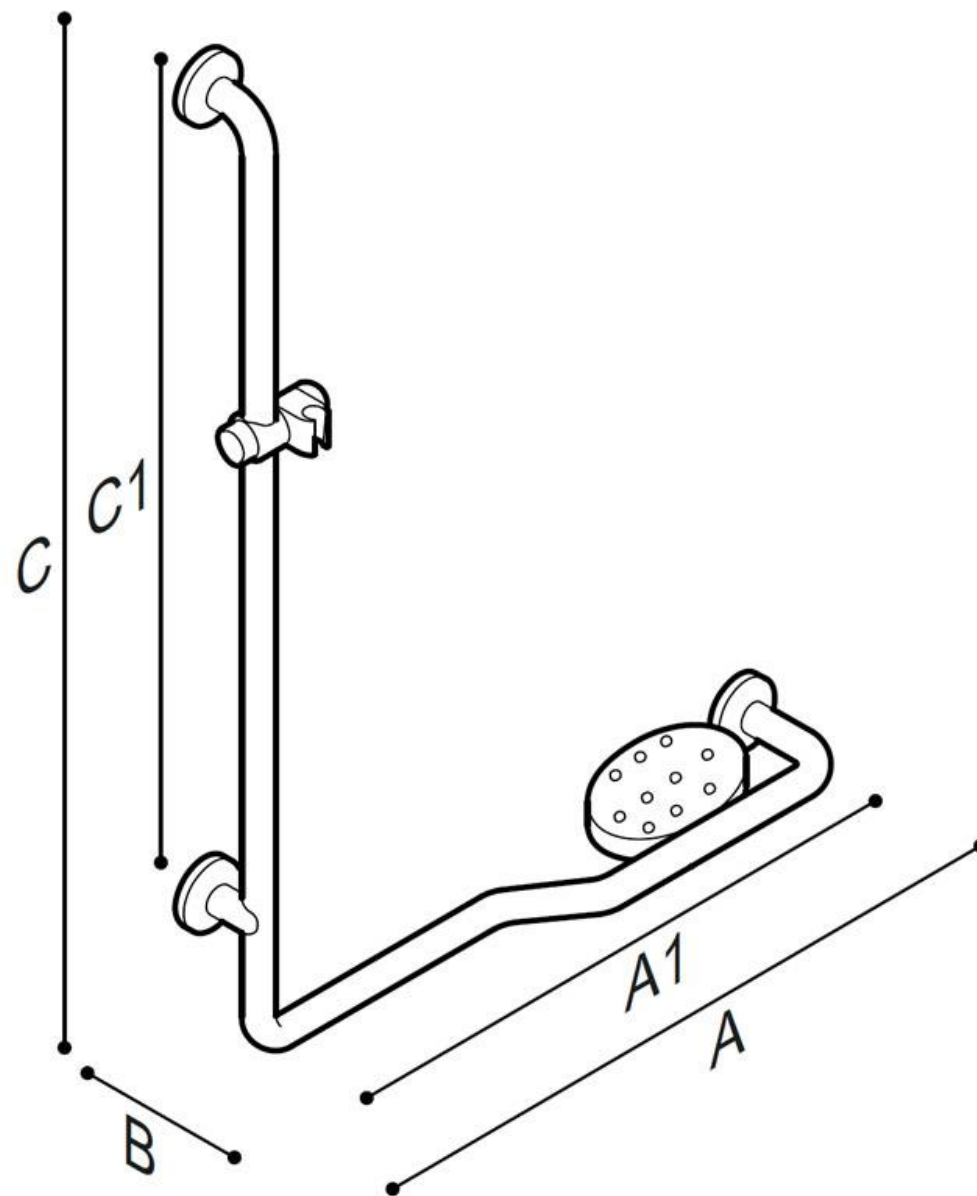

Artn°	AxBxC (mm)	A1xB1 (mm)	Gewicht	Belasting
<b>G01JOR04xx</b>	703x165x1203	620x1120	3.62	150
<b>G01JOL04xx</b>	703x165x1203	620x1120	3.62	150

### Opties:



Ergonomic shower holder  
Y87JOS04xx



Shower head  
H51GHS35



Flexible hose for shower head cm 175  
H51GHS36



## HANDGREEP TUBOCOLOR met douche & zeep houder

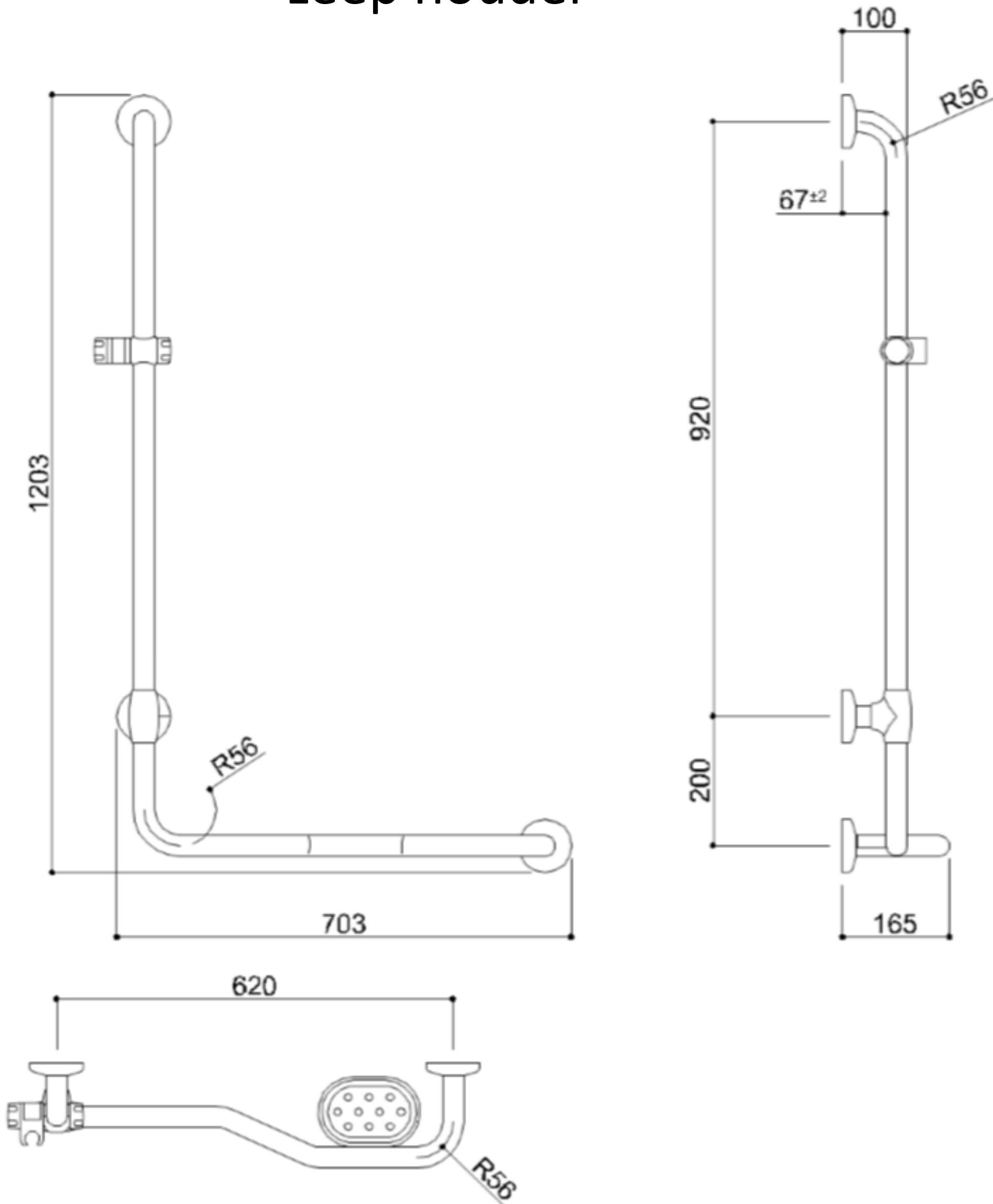



## HANDGREEP TUBOCOLOR met douche & zeep houder



**Optie:** Ergonomische verstelbare douchehouder  
Verkrijgbaar in verschillende kleuren Artn° Y87JOS04

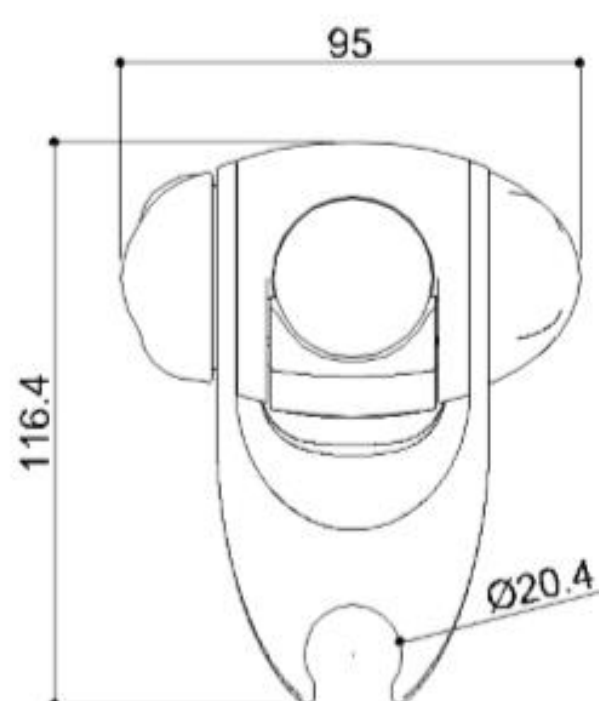
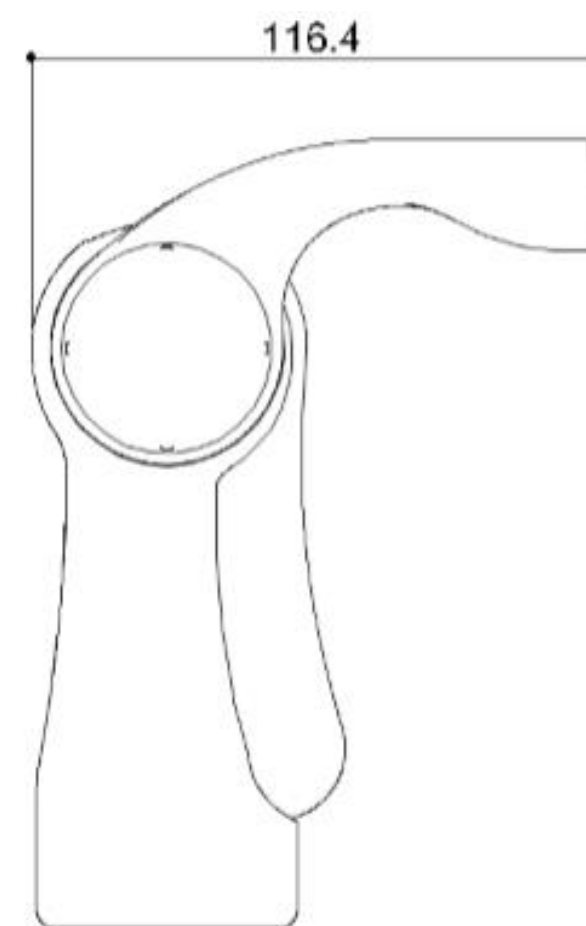
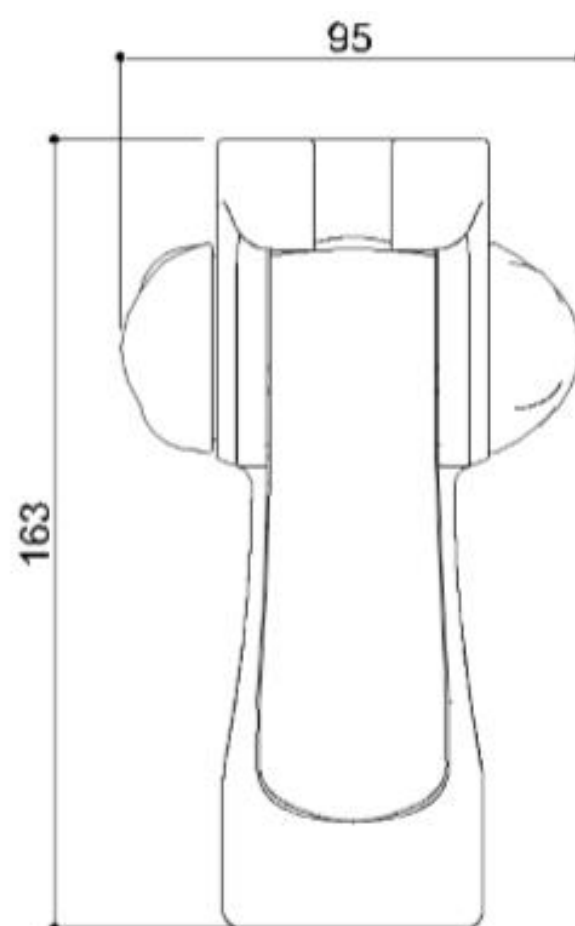



## HANDGREEP TUBOCOLOR met douche & zeep houder



**Optie:** Ergonomische verstelbare douchekop met 3 functies, 130 mm  
Verkrijgbaar in chrome Artn° H51GHS35

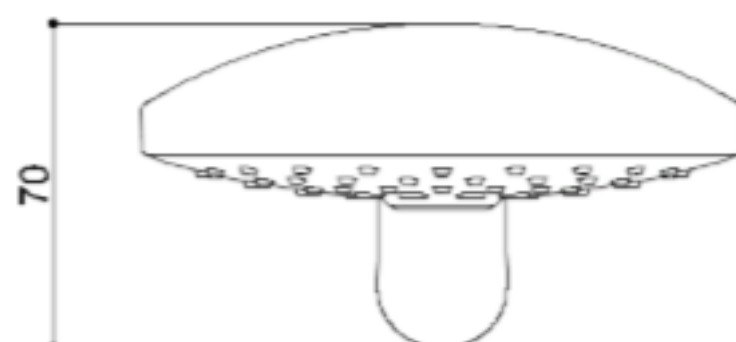
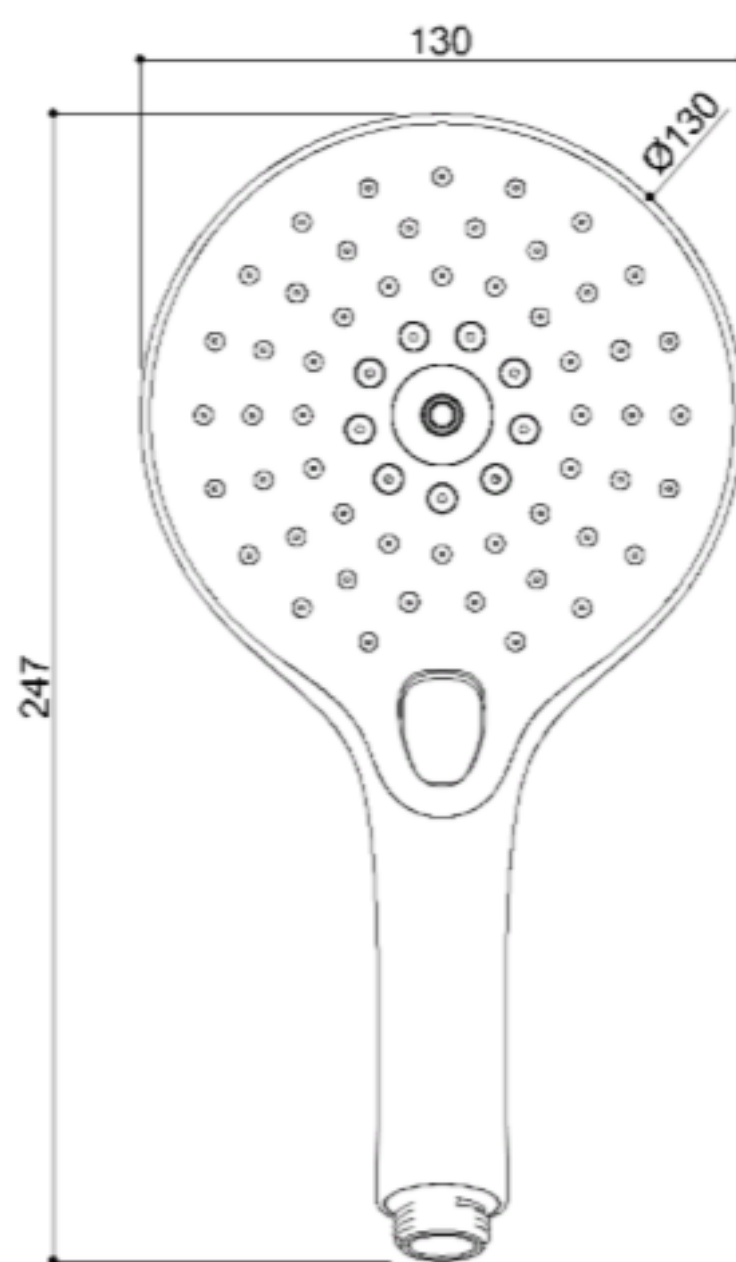





## HANDGREEP TUBOCOLOR met douche & zeep houder



**Optie:** Doucheslang verkrijgbaar in chrome Artn° H51GHS36

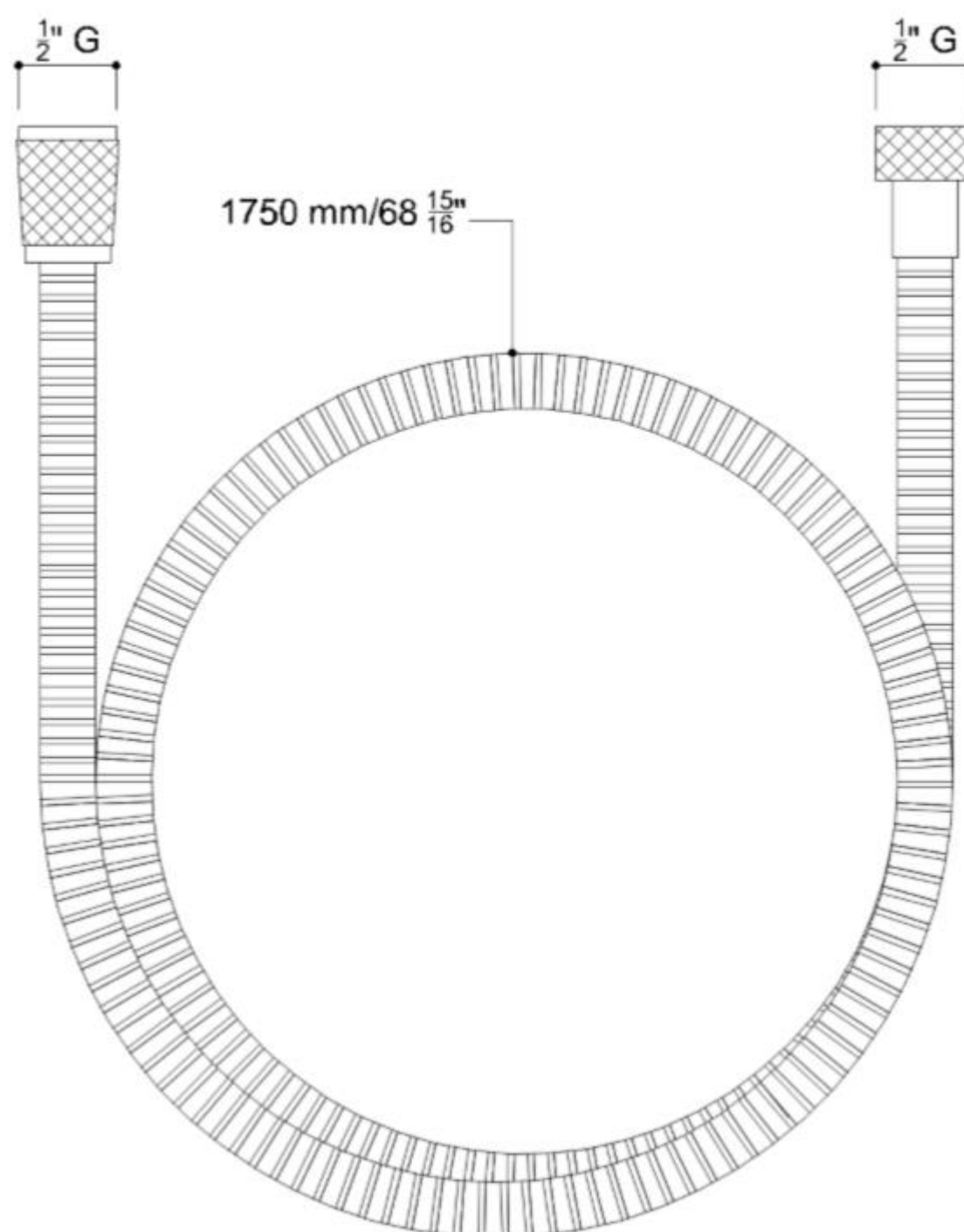



## HANDGREEP TUBOCOLOR met douche & zeep houder



# BioCote® technology

BioCote®-technologie wordt gebruikt in de handgrepen, douchezitjes en accessoires om ze te beschermen tegen een breed scala aan microben, waaronder bacteriën, schimmels en sommige virussen.

Eenmaal opgenomen in een product, vermindert BioCote®-technologie op basis van zilverionen actief het risico op kruisbesmetting door de kolonisatie van microben op een beschermd oppervlak te voorkomen. De ingebouwde bescherming werkt constant om de aanwezigheid van microben te verminderen. Dankzij het multimodale effect van BioCote®

BioCote® vermindert het aantal microben op een oppervlak met tot 86% in slechts 15 minuten, 99,5% in twee uur en tot 99,99%. BioCote® vormt een actieve aanvulling op bestaande hygiënepraktijken, zoals handhygiëne en grondige productreinigingsregimes, en biedt een extra beschermingslaag.

Waarom zou u om microben en antimicrobiële technologie geven?

Bacteriën zoals MRSA en Escherichia-coli kunnen maandenlang op harde oppervlakken overleven, wat leidt tot mogelijke kruisbesmetting;

- Microben zoals schimmels kunnen voedingsstoffen uit materialen halen en zo hun eigenschappen en prestaties in gevaar brengen, waardoor de levensduur van een product wordt verkort;
- BioCote®-technologie heeft bewezen bepaalde virussen te deactiveren;
- BioCote® antimicrobiële technologie bleek effectief te zijn tegen een breed scala aan microben zoals: Staphylococcus aureus, Escherichia coli, Salmonella, Listeria, Legionella, Campylobacter, Pseudomonas, Shigella, H1N1-virus, Aspergillus Niger.

Hoe werkt BioCote® op de handgrepen, douchezitjes en accessoires?

- BioCote® wordt op de plaats van fabricage in producten verwerkt;
- Zilverionen zijn dan beschikbaar om op te treden tegen bacteriën die het oppervlak verontreinigen;
- Zilverionen binden zich met de bacteriën;
- Zilverionen beschadigen de bacteriën op een aantal manieren en verstoren hun normale werking;
- Bacteriën kunnen zich niet voortplanten en sterven daardoor af.





**Hakoma**  
sanitair