





HANDGREEP TUBOCOLOR

















BioCote® technology

Handgrepen om in hoeken te plaatsen, van naadloze verzinkte stalen buis, gecoat met antibacterieel, (BioCote) in soft-touch vinyl

Deze handgreep is ideaal voor het gebruik in douches en sanitaire ruimtes, voor een maximale veiligheid voor de gebruiker.

- Toepassing: privé woningen, serviceflats, woonzorgcentra en hotels, enz....
- Draagcapaciteit: Verticaal 150kg, horizontaal 150kg
- Afmetingen: zie tabel

- Kleuren:

														
B1	B2	D1	D2	D4	G1	G2	I1	I2	P4	R1	R7	W1	Y1	Y3



HANDGREEP TUBOCOLOR

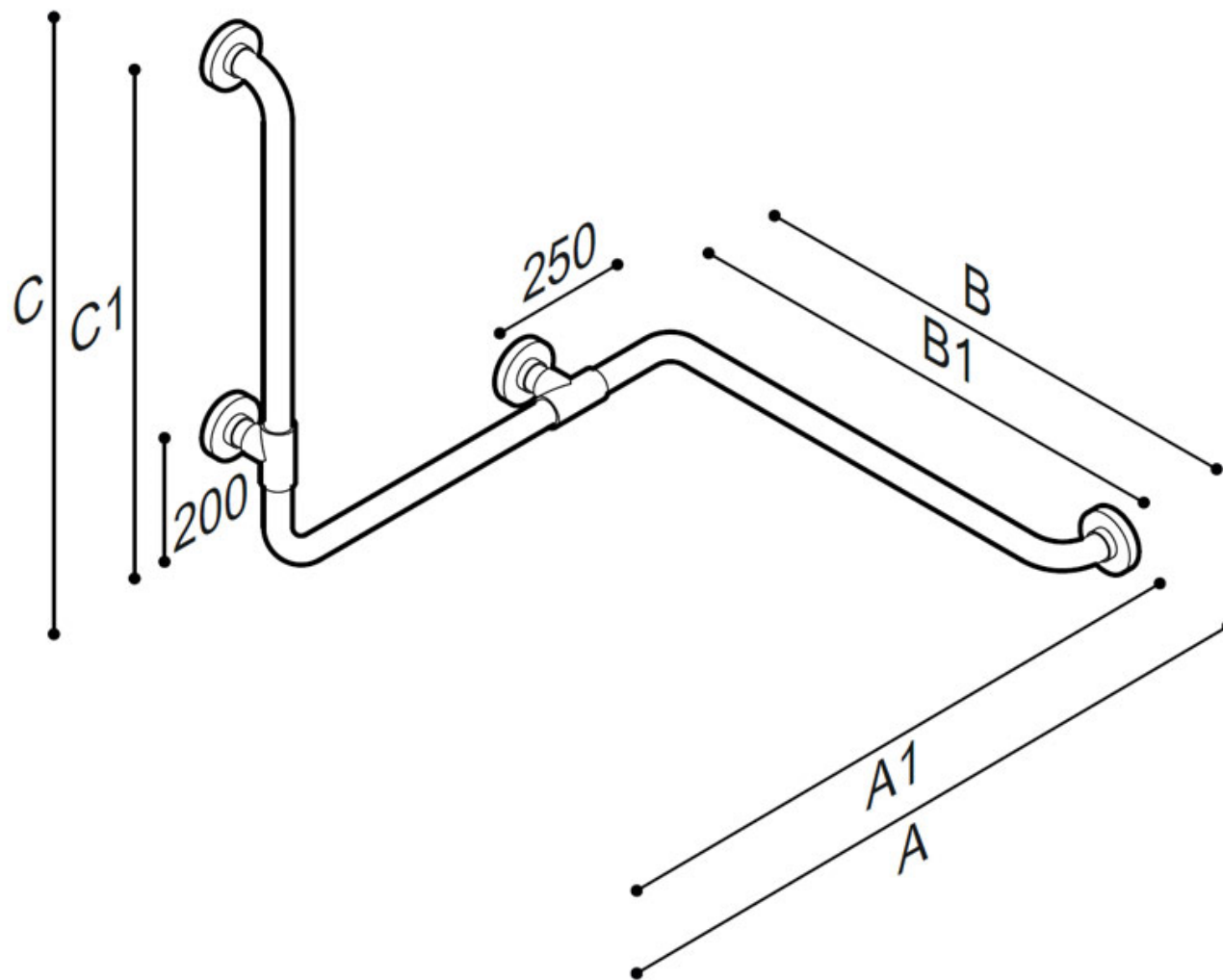

Artn°	AxBxC (mm)	A1xB1xC1 (mm)	Gewicht	Belasting
G01JBS06xx	660x660x660	620x620x580	4.17	150
G01JBS07xx	760x760x760	720x720x680	4.85	150
G01JBS08xx	1000x660x660	960x620x580	4.90	150
G01JBS09xx	1600x660x660	1560x620x580	6.54	150
G01JBS10xx	1700x760x760	1660x720x680	7.14	150

Opties:



Ergonomic shower holder
Y87JOS04xx



Shower head
H51GHS35



Flexible hose for shower head cm 175
H51GHS36



HANDGREEP TUBOCOLOR G01JBS06

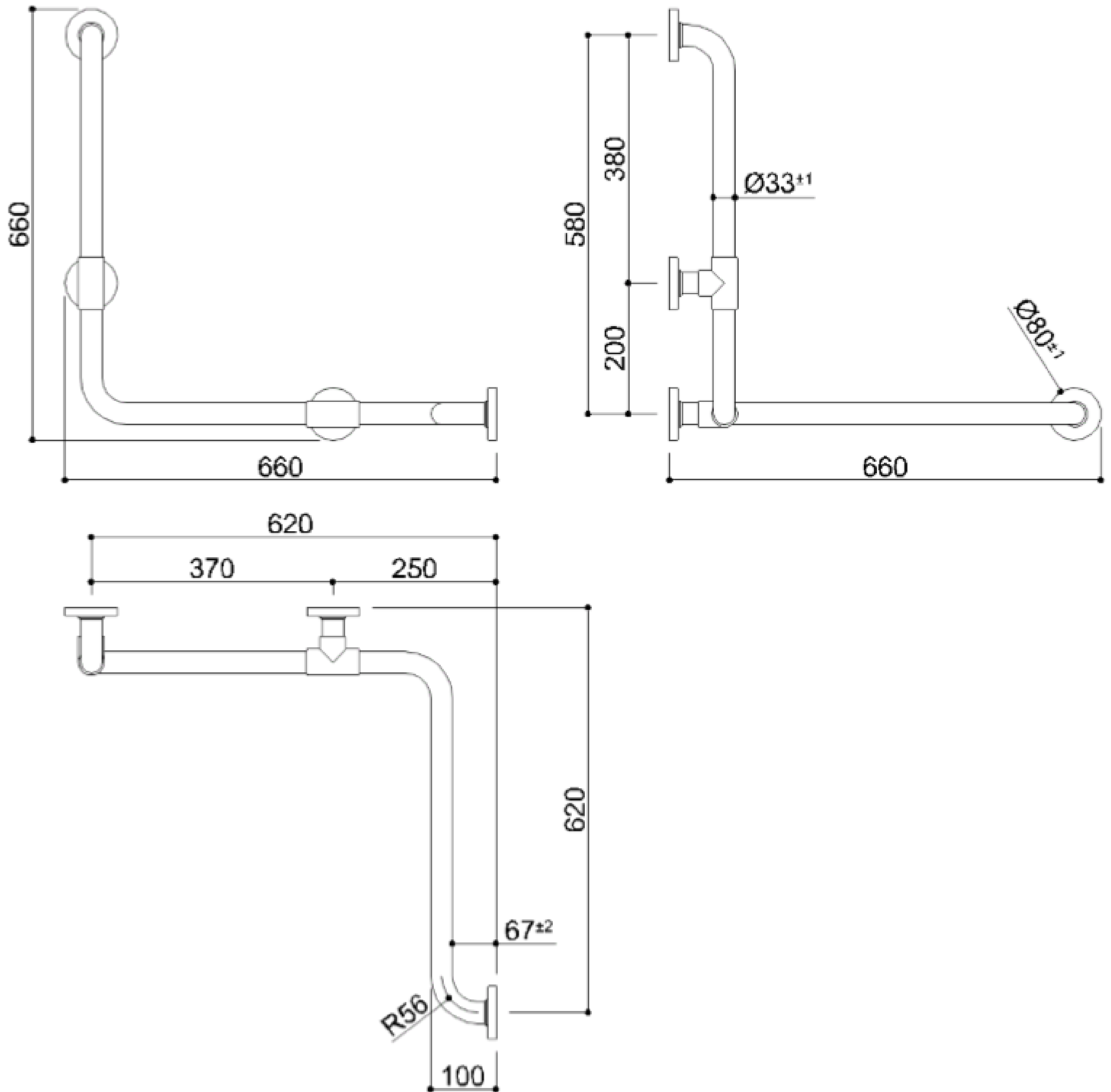



HANDGREEP TUBOCOLOR G01JBS07

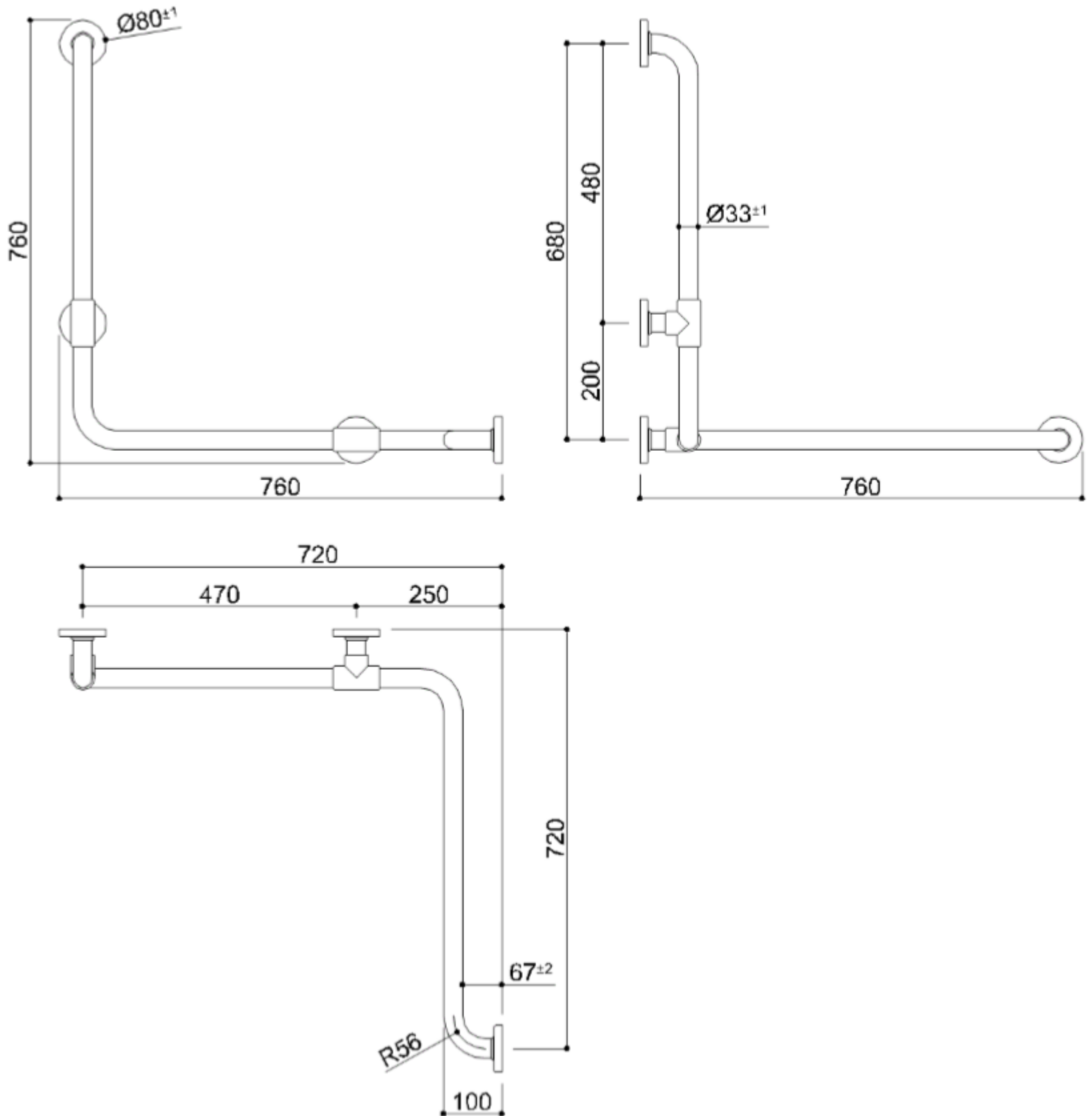



HANDGREEP TUBOCOLOR G01JBS08

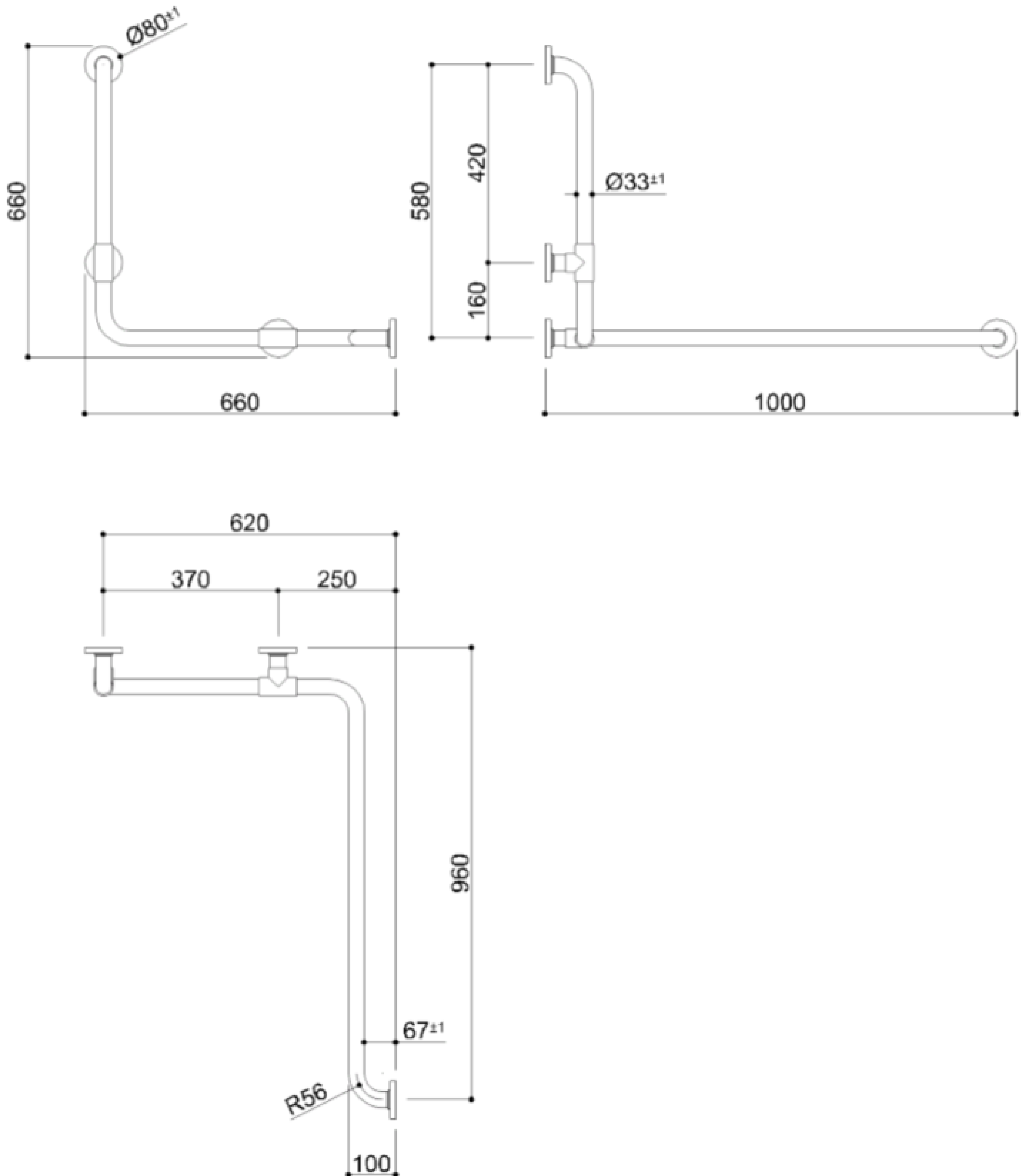



HANDGREEP TUBOCOLOR G01JBS09

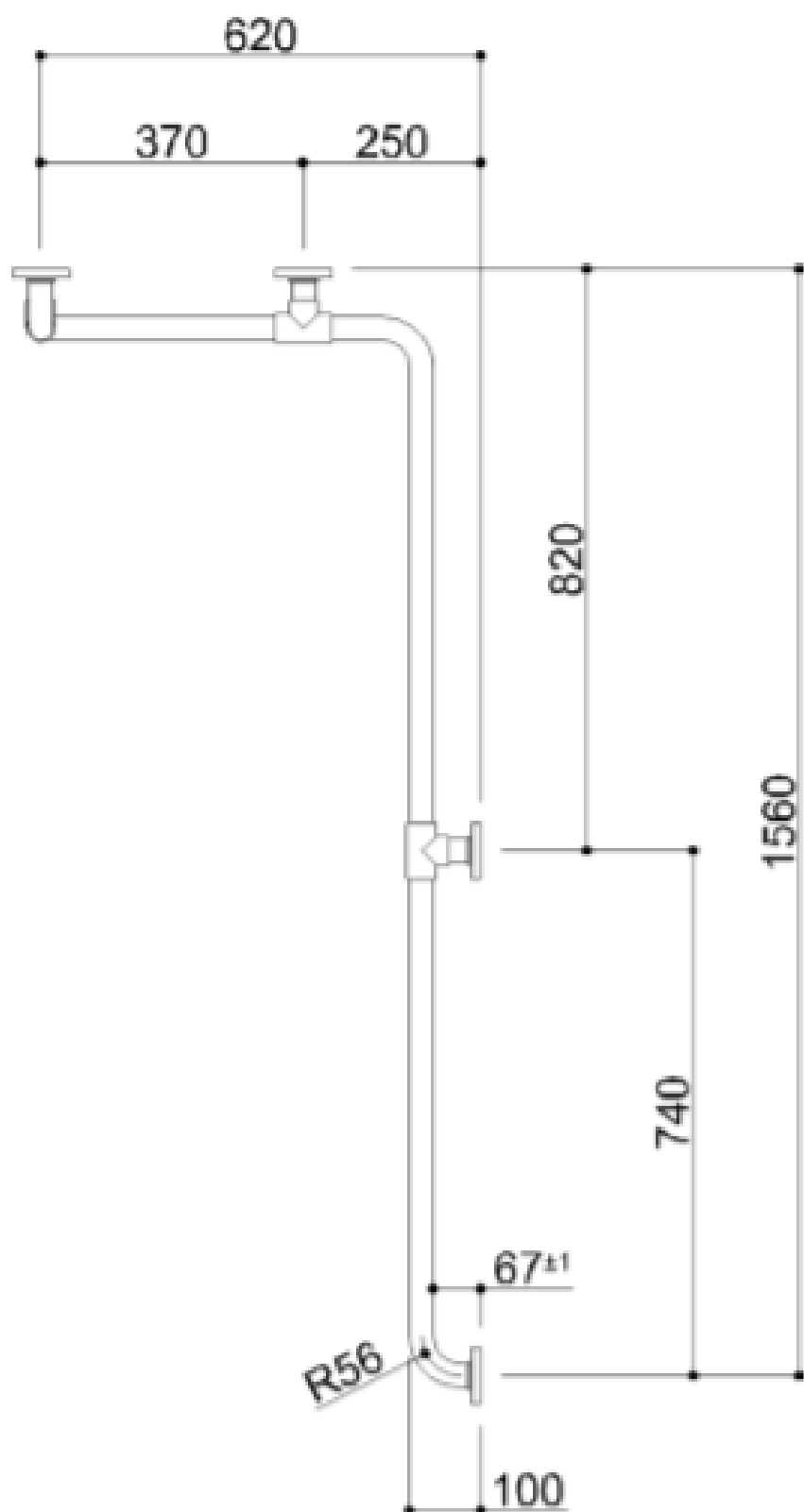
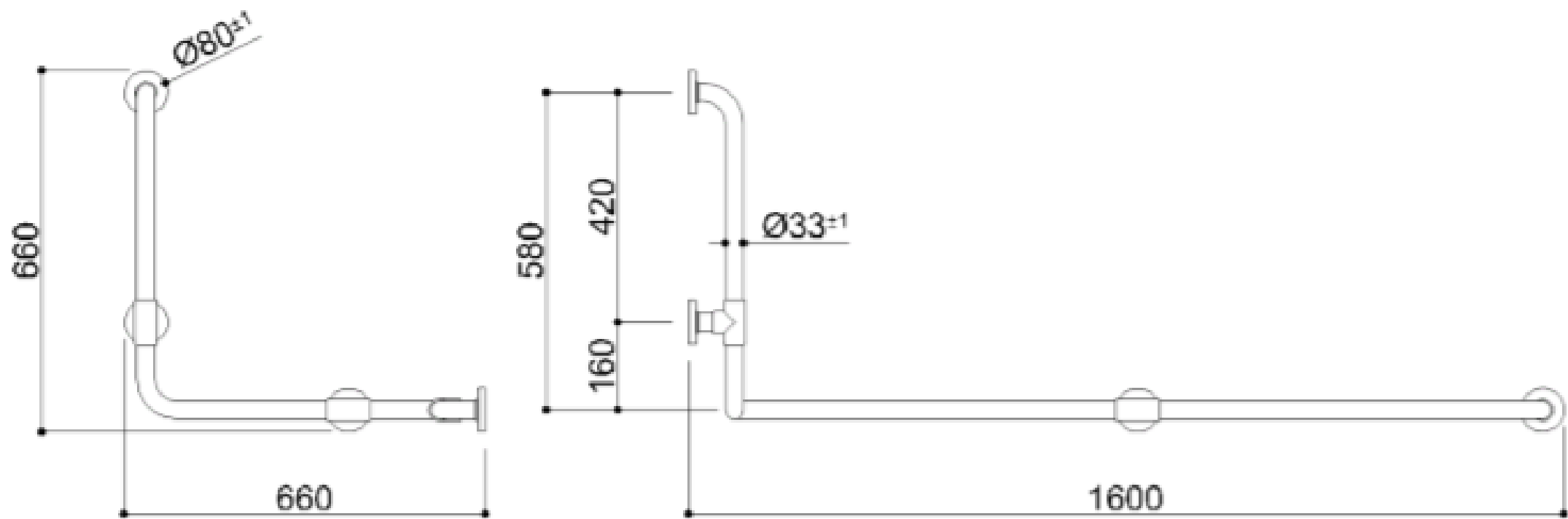



HANDGREEP TUBOCOLOR G01JBS10

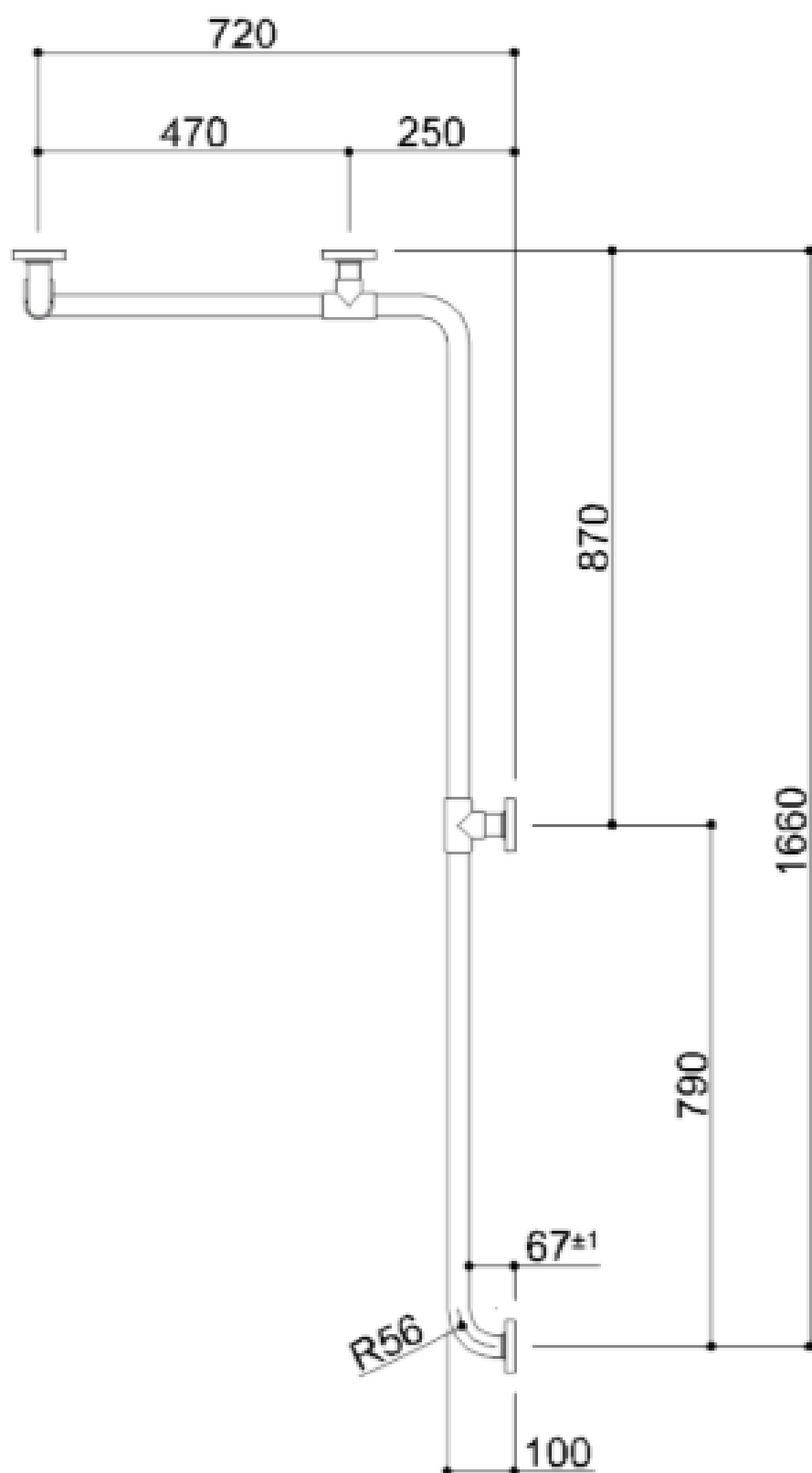
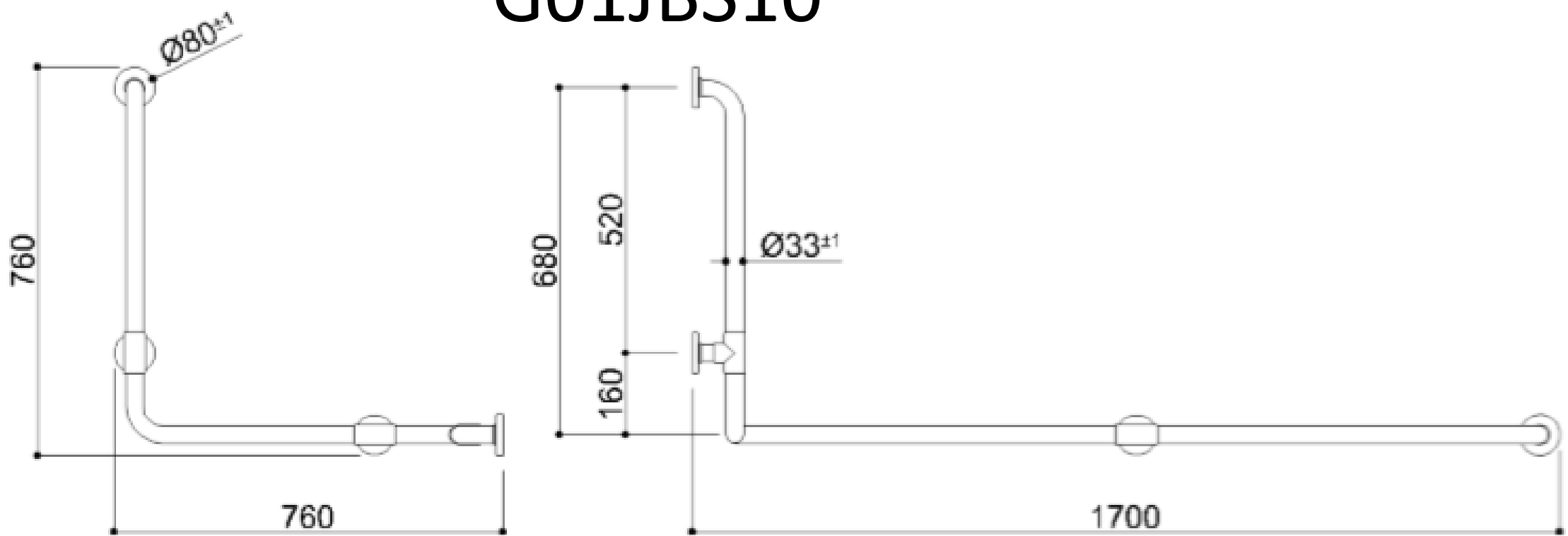

HANDGREEP TUBOCOLOR



Optie: Ergonomische verstelbare douchehouder
Verkrijgbaar in verschillende kleuren Artn° Y87JOS04

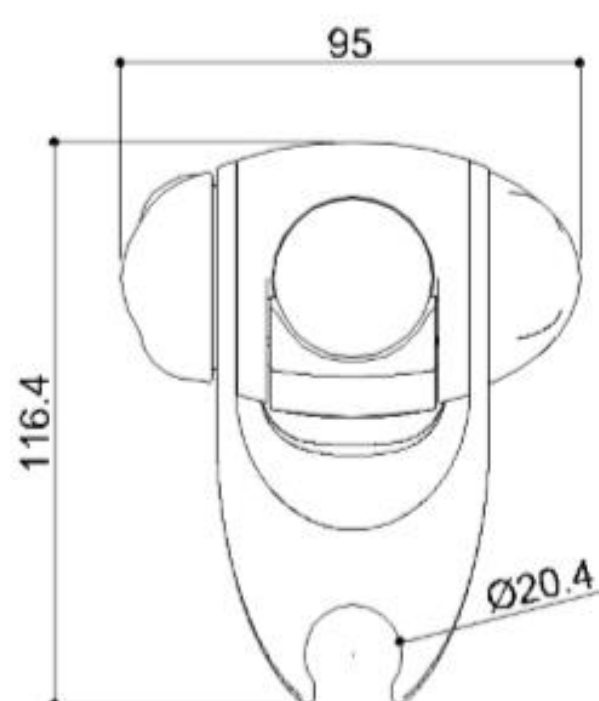
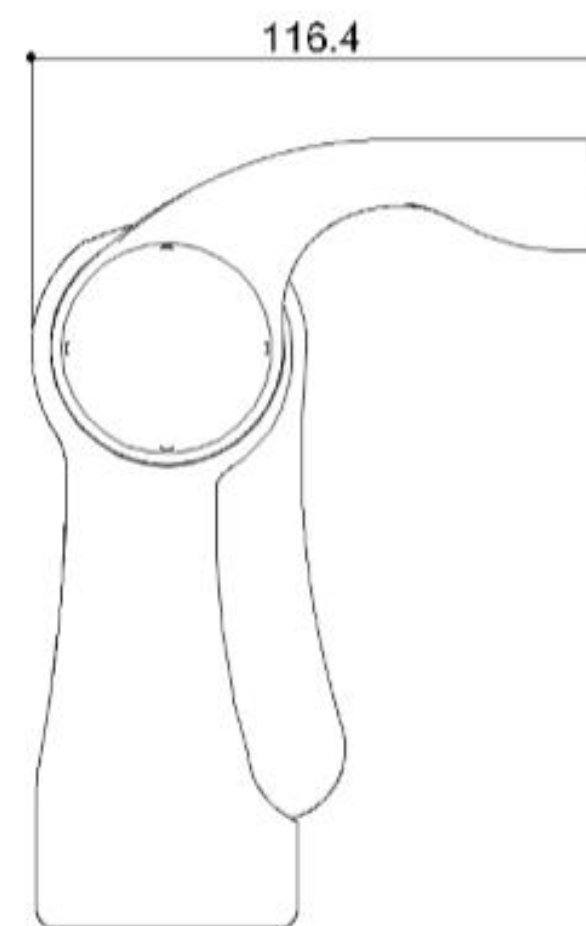
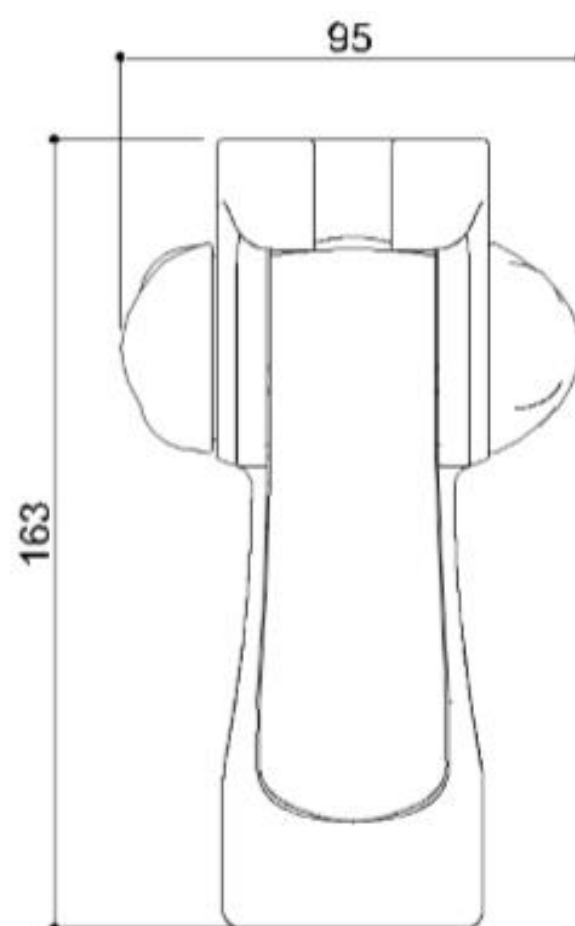

HANDGREEP TUBOCOLOR



Optie: Ergonomische verstelbare douchekop met 3 functies, 130 mm
Verkrijgbaar in chrome Artn° H51GHS35

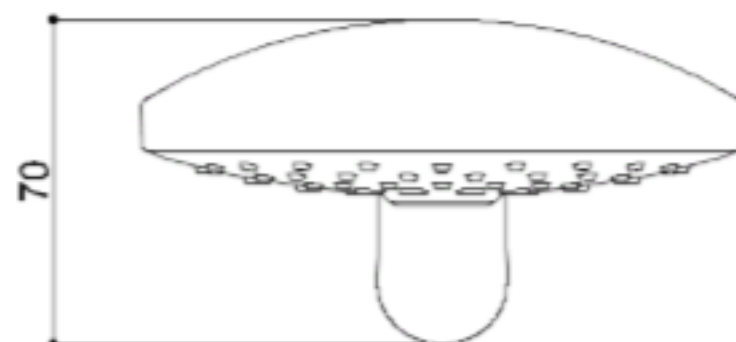
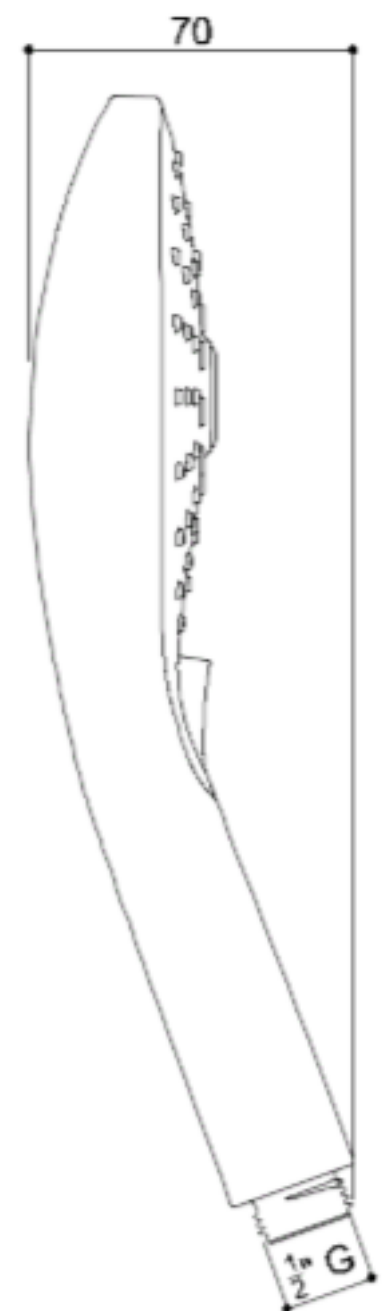
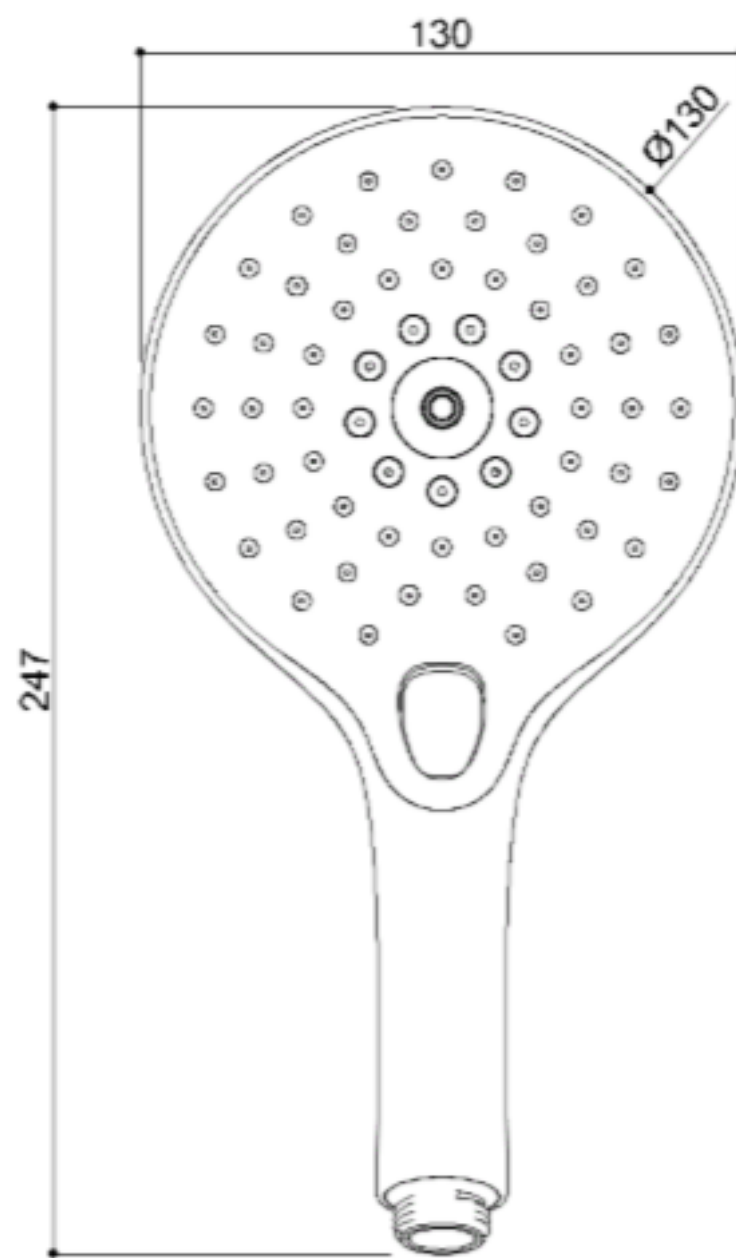



HANDGREEP TUBOCOLOR



Optie: Doucheslang verkrijgbaar in chrome Artn° H51GHS36

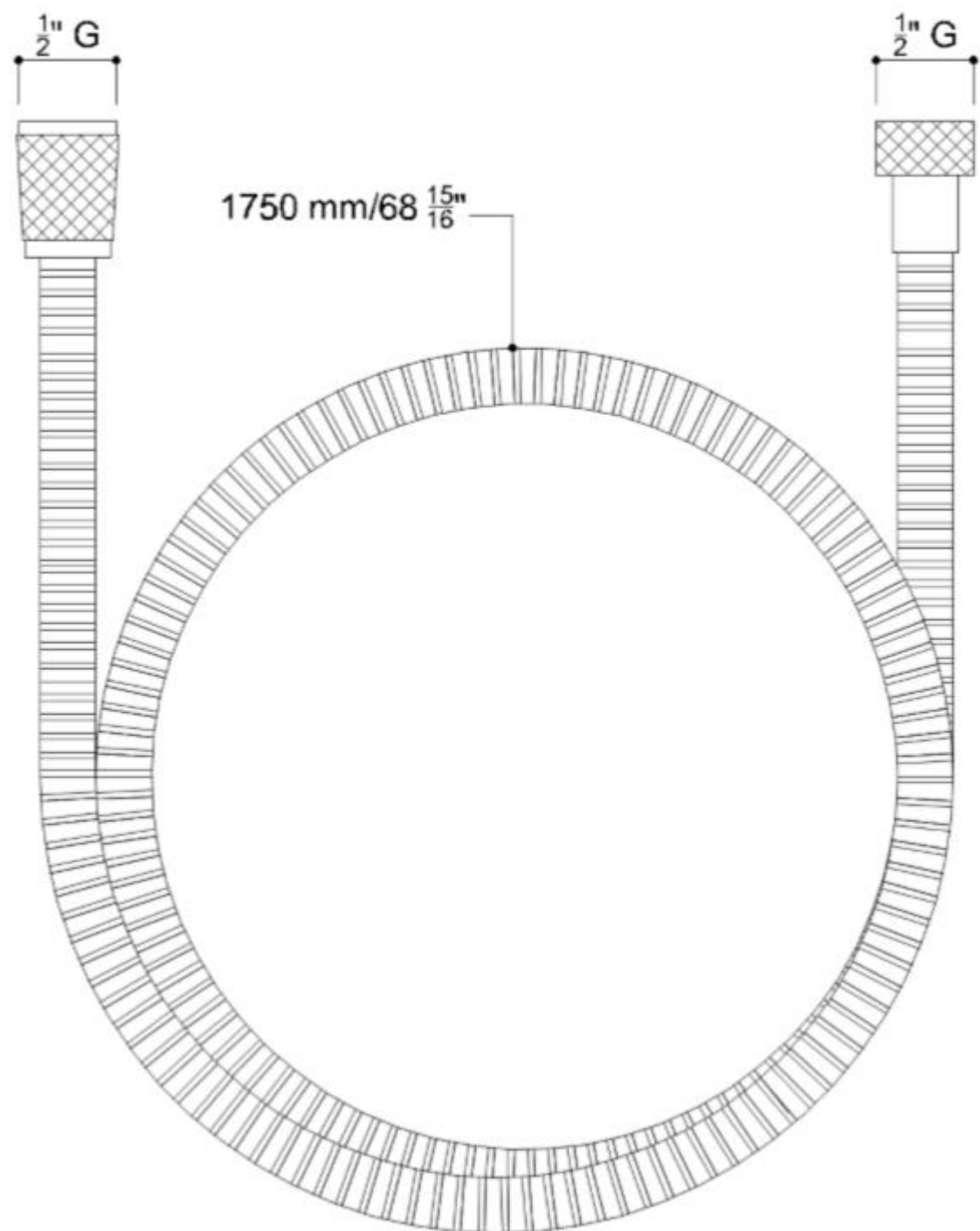



HANDGREEP TUBOCOLOR



BioCote® technology

BioCote®-technologie wordt gebruikt in de handgrepen, douchezitjes en accessoires om ze te beschermen tegen een breed scala aan microben, waaronder bacteriën, schimmels en sommige virussen.

Eenmaal opgenomen in een product, vermindert BioCote®-technologie op basis van zilverionen actief het risico op kruisbesmetting door de kolonisatie van microben op een beschermd oppervlak te voorkomen. De ingebouwde bescherming werkt constant om de aanwezigheid van microben te verminderen. Dankzij het multimodale effect van BioCote®

BioCote® vermindert het aantal microben op een oppervlak met tot 86% in slechts 15 minuten, 99,5% in twee uur en tot 99,99%. BioCote® vormt een actieve aanvulling op bestaande hygiënepraktijken, zoals handhygiëne en grondige productreinigingsregimes, en biedt een extra beschermingslaag.

Waarom zou u om microben en antimicrobiële technologie geven?

Bacteriën zoals MRSA en Escherichia-coli kunnen maandenlang op harde oppervlakken overleven, wat leidt tot mogelijke kruisbesmetting;

- Microben zoals schimmels kunnen voedingsstoffen uit materialen halen en zo hun eigenschappen en prestaties in gevaar brengen, waardoor de levensduur van een product wordt verkort;
- BioCote®-technologie heeft bewezen bepaalde virussen te deactiveren;
- BioCote® antimicrobiële technologie bleek effectief te zijn tegen een breed scala aan microben zoals: Staphylococcus aureus, Escherichia coli, Salmonella, Listeria, Legionella, Campylobacter, Pseudomonas, Shigella, H1N1-virus, Aspergillus Niger.

Hoe werkt BioCote® op de handgrepen, douchezitjes en accessoires?

- BioCote® wordt op de plaats van fabricage in producten verwerkt;
- Zilverionen zijn dan beschikbaar om op te treden tegen bacteriën die het oppervlak verontreinigen;
- Zilverionen binden zich met de bacteriën;
- Zilverionen beschadigen de bacteriën op een aantal manieren en verstoren hun normale werking;
- Bacteriën kunnen zich niet voortplanten en sterven daardoor af.



Hakoma
sanitair